

STERILIS SOLUTIONS

SMALL CHANGE. BIG IMPACT.

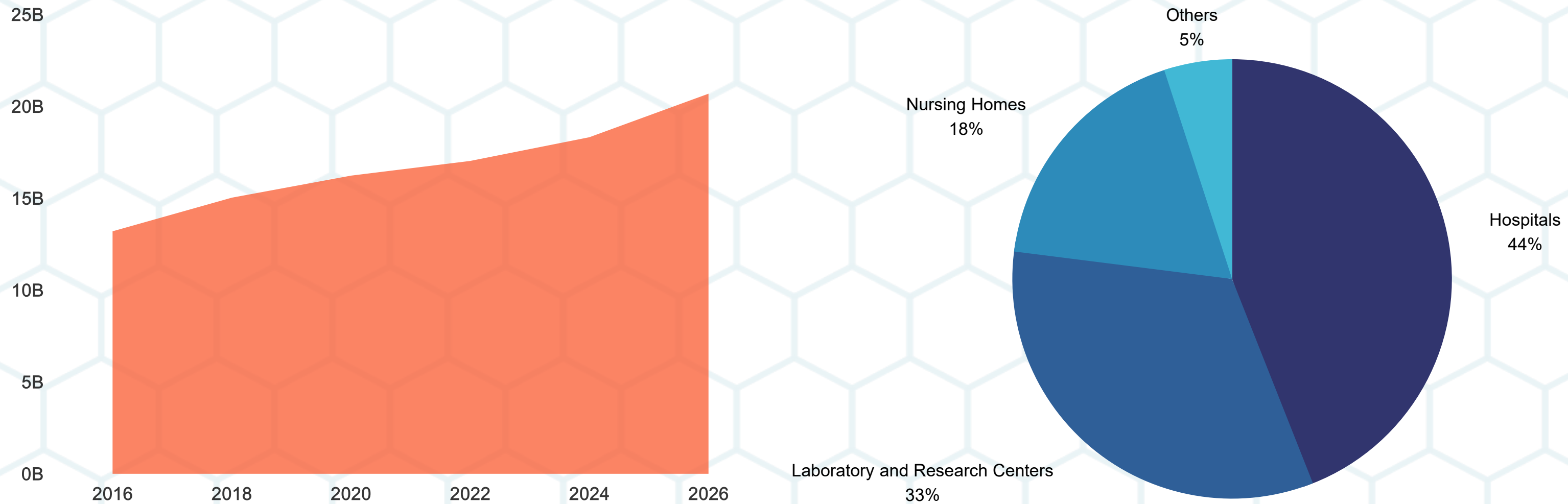

GROWING, MULTI-BILLION DOLLAR RMW MARKET



- The global medical waste management market is expected to grow from \$16.23 billion in 2021 to \$17.03 billion in 2022 at a compound annual growth rate (CAGR) of 5.0% and is expected to reach \$20.69 billion in 2026.
- Key factors that are driving the market growth include inflation, fewer incinerator options, cost of fuel, labor shortages, rising prevalence of diseases, and growth of the overall medical and healthcare industry.



OPERATIONAL & ENVIRONMENTAL CHALLENGES

Collection and Storage



Incineration, Emissions, and Landfill

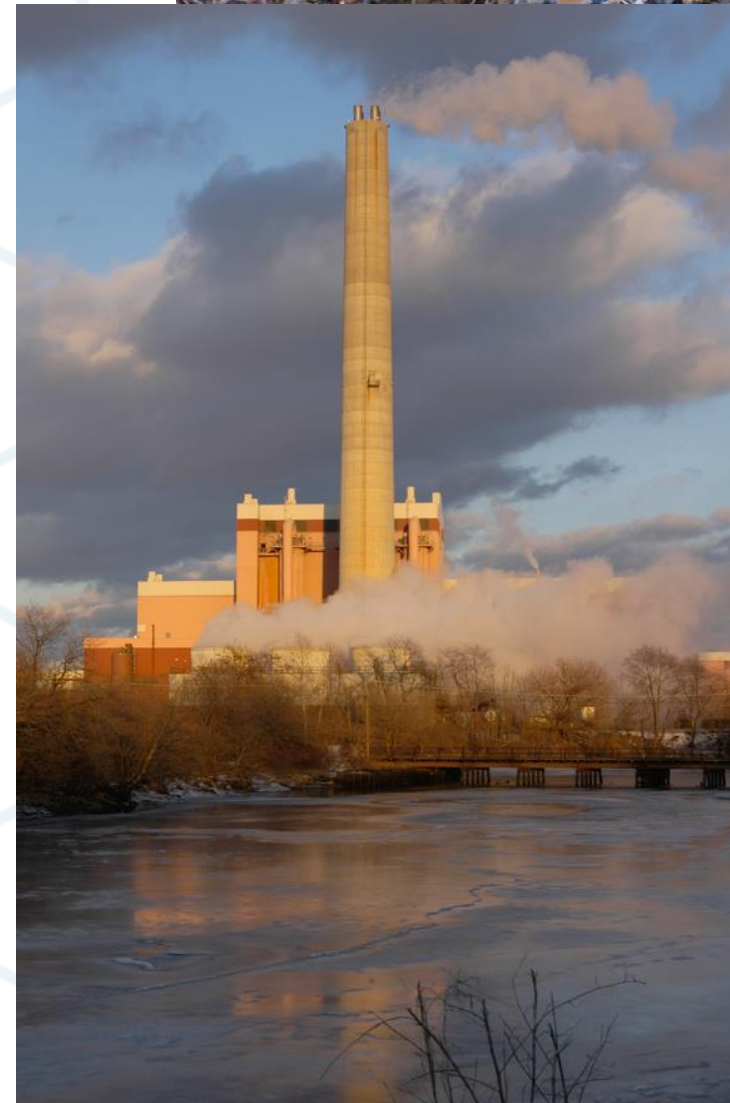

Hauling and Liability



MEDICAL WASTE STREAMS AND CATEGORIES

Red Sharps Container



- Needles
- Ampules
- Broken Glass
- Blades/Razors

Bio-Hazard Red Bag



- Collection
- Cups, Swabs
- Blood tubes/bags
- PPE, Dressings/
Cotton Swabs
- Cultures, stacks
- Dialysis kits/tubing

Blue Sharps



- Pharmaceuticals
- Pills
- Injectable
Antibiotics

Yellow/Black Sharps



- Chemotherapy
Medication
- Pathological waste



RMW: REGULATION AND LIABILITIES



Primarily regulated at the State level

- Disposal, labeling and storage requirements are complex and vary from state-to-state
- Tracking and logging RMW from generation to disposal required
- Records must be maintained for 3-5 years
- EPA and OSHA also regulate RMW

Liabilities

- Originator of RMW has liability cradle-to-grave (sterile disposal and tracking)
- Liability does not transfer to hauling companies
- Fines can be steep
 - PA hospital fined \$538K when its untreated RMW was found in a landfill
 - A hospital fined \$70K when mislabeled RMW was sent to public transfer station
 - PA dentist faced \$125K in fines and 10 years in prison after his RMW washed ashore in NJ



OLD WAY

- Collection, Storage, Service Level Issues
- Incineration, Emissions, and Landfill
- Hauling, Cradle to Grave Liability, and Increasing Costs

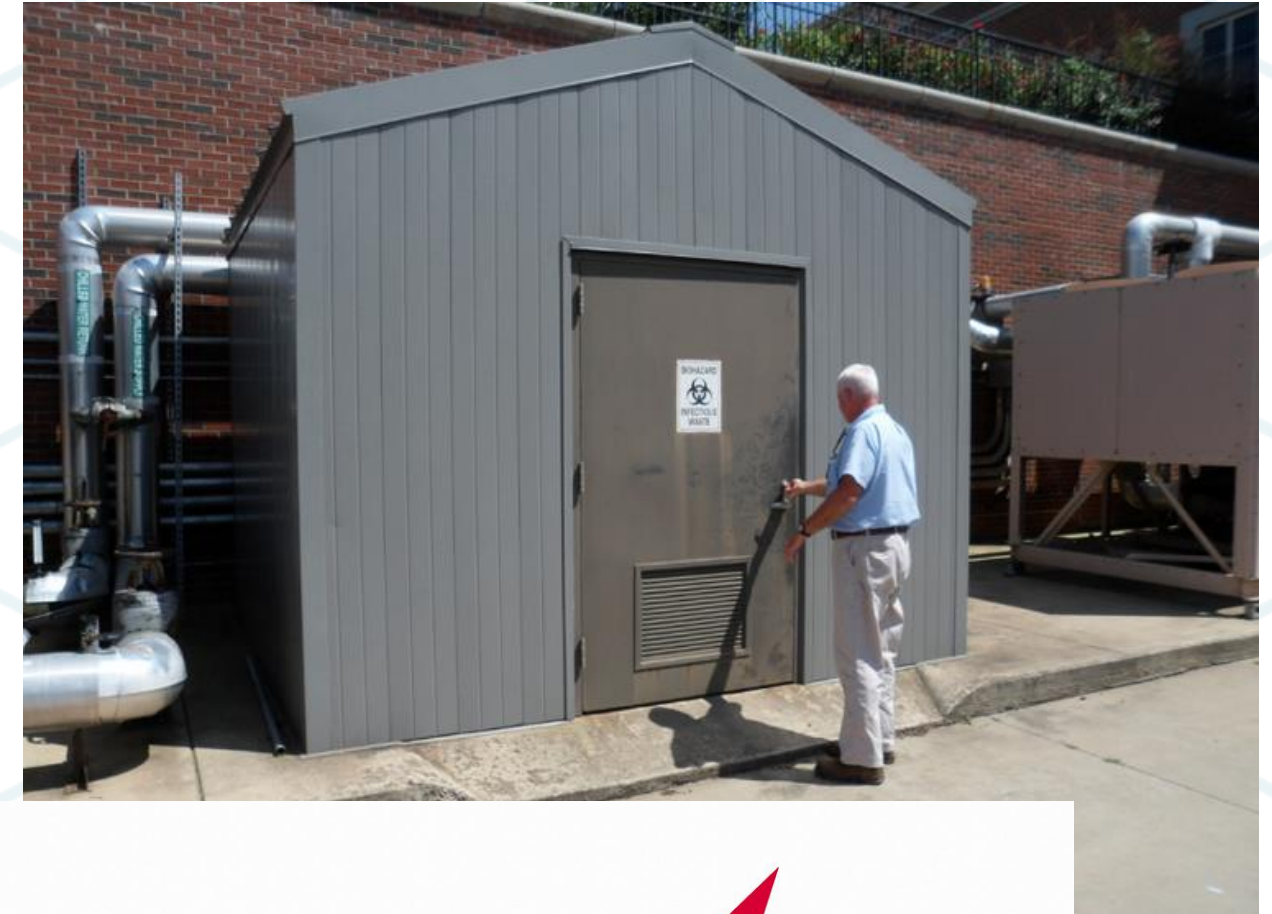

WHAT WE'VE HEARD:

"The **environmental impact** of incineration isn't in line with our **sustainability goals**."

"**Fees on fees on fees.** What is there *not* a **fee** for?"

"Year over year **cost increase** from 8% - 18%."

"We're **liable** for the actions of our third-party hauler."

"We've had numerous **service level issues** with our hauler."

"We have **no bargaining power** for what we pay our haulers."

Do any of these challenges resonate with you too?



OLD WAY VS NEW WAY



SMALL CHANGE. **BIG IMPACT.**

Impact operating costs

Impact carbon footprint

Impact regulatory compliance

Impact liability

Impact third-party dependency

Impact safety



There are several ways the Sterilis Solutions Remediator can have a positive impact on your regulated medical waste.

THE REMEDIATOR

36"W x 24"D x 47"H;
Easily fits into a
pharmacy, clinic,
lab, or dirty room

Simple to use: Log in,
load, and press 'start'

Automatically logs and stores
compliance data.
Prompts and records
bio-challenges

60-Minute
Cycle

No odor and quiet

No Plumbing
Required

Portable

220V Model

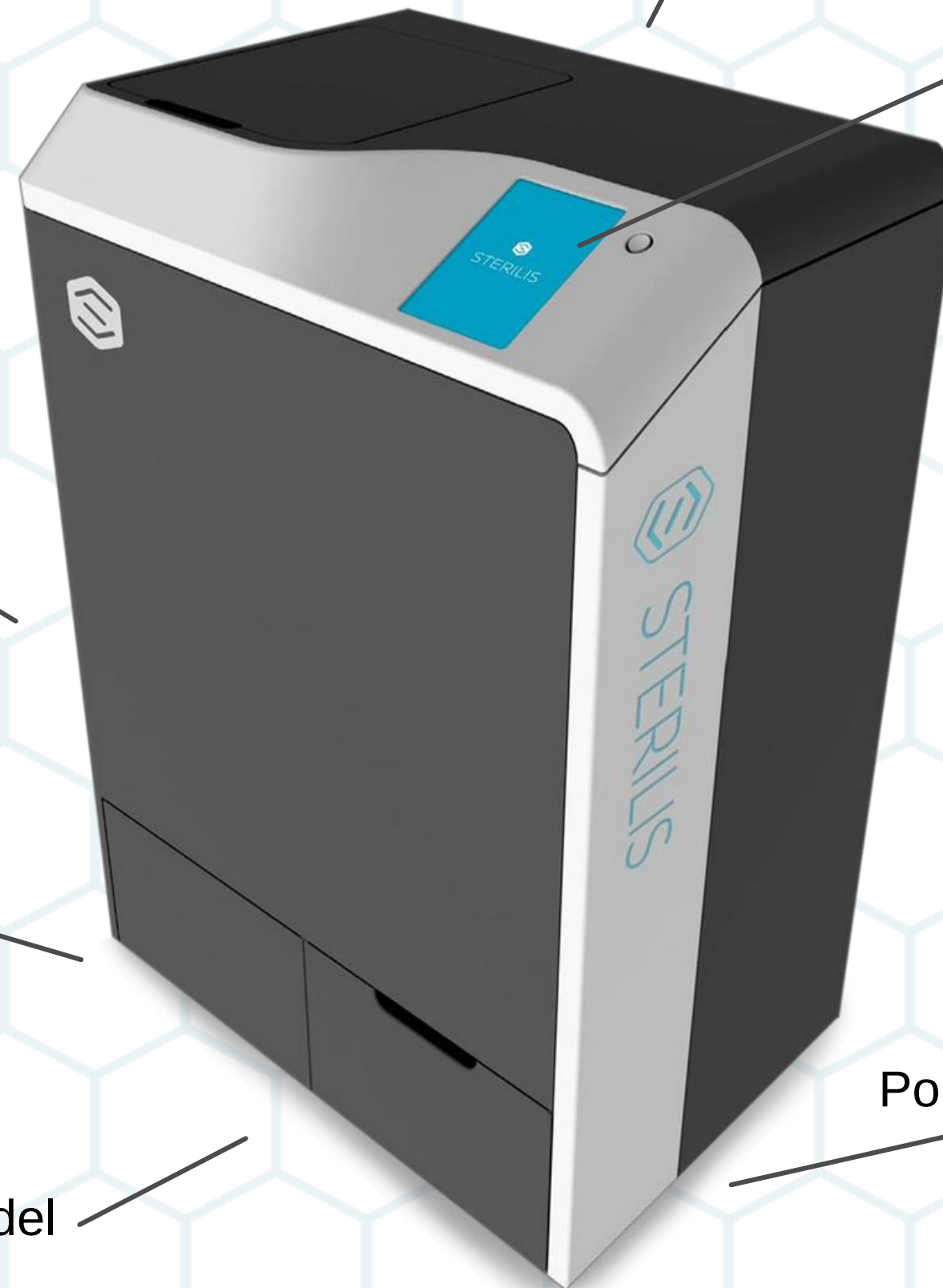

HOW IT WORKS



REDUCE AND REUSE



LOAD RED BAG/ SHARPS



SELECT WASTE TYPE

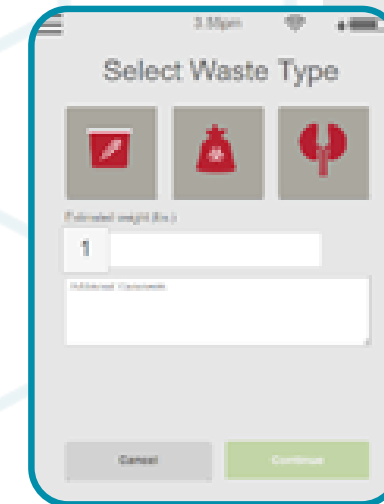

GRIND



EASY REMOVAL

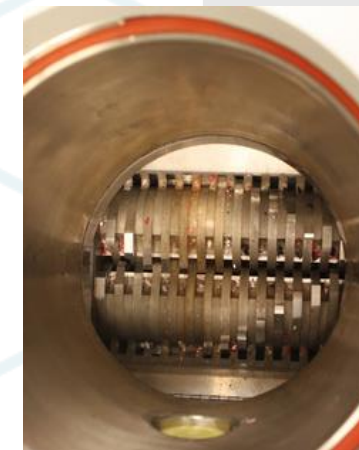

STERILIZATION PROCESS

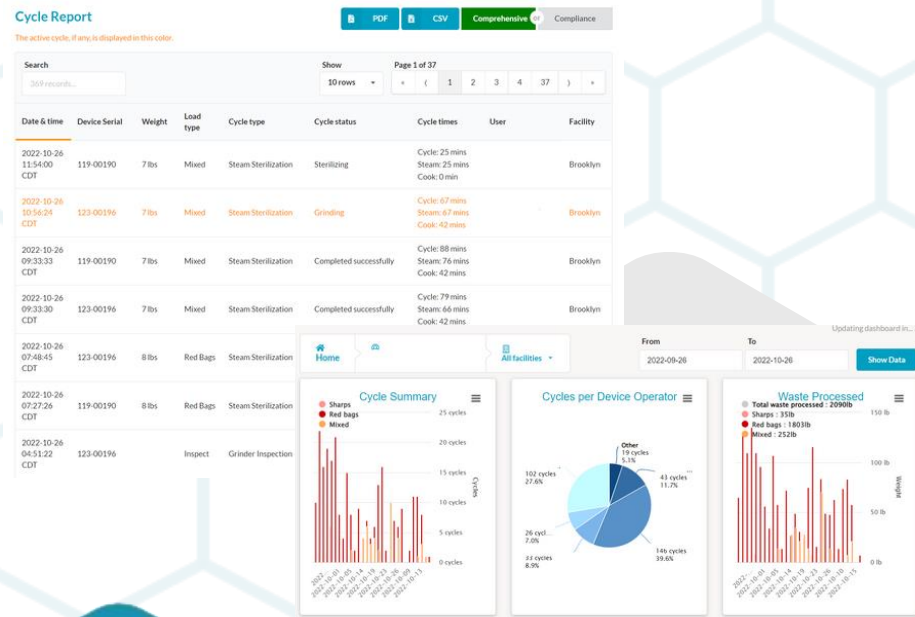
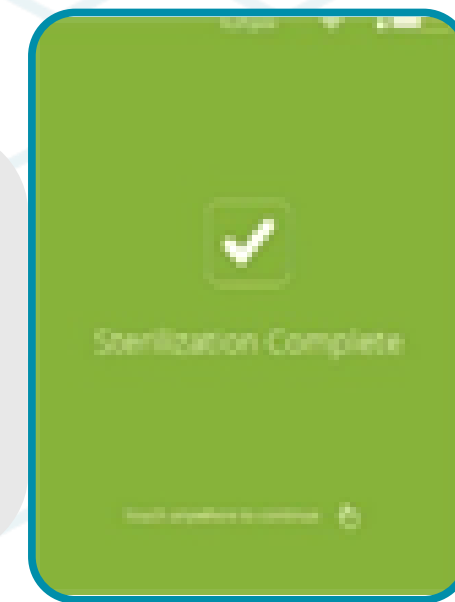

COMPLIANCE



3D VIEW



Sterilis Product



TAKE A CLOSER LOOK UNDER THE HOOD

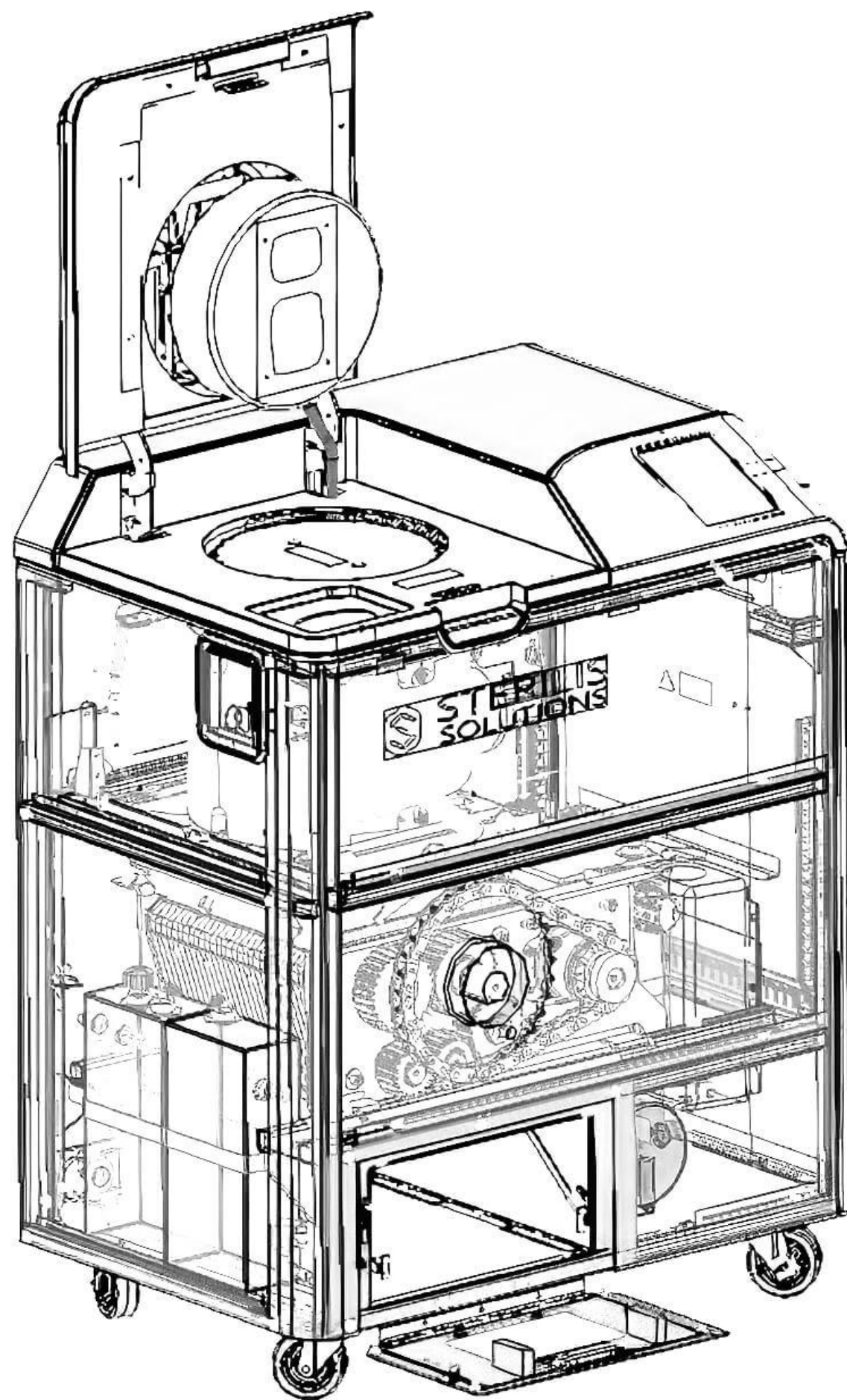

CLOUD-BASED REGULATORY COMPLIANCE



dcrosson ▾

Updating dashboard in... 39

Device

Customer Devices Only

LabQ Clinical Diagnostics @ Brooklyn : 119-00190 ▾

From

2022-11-09

To

2022-12-09

Show Data

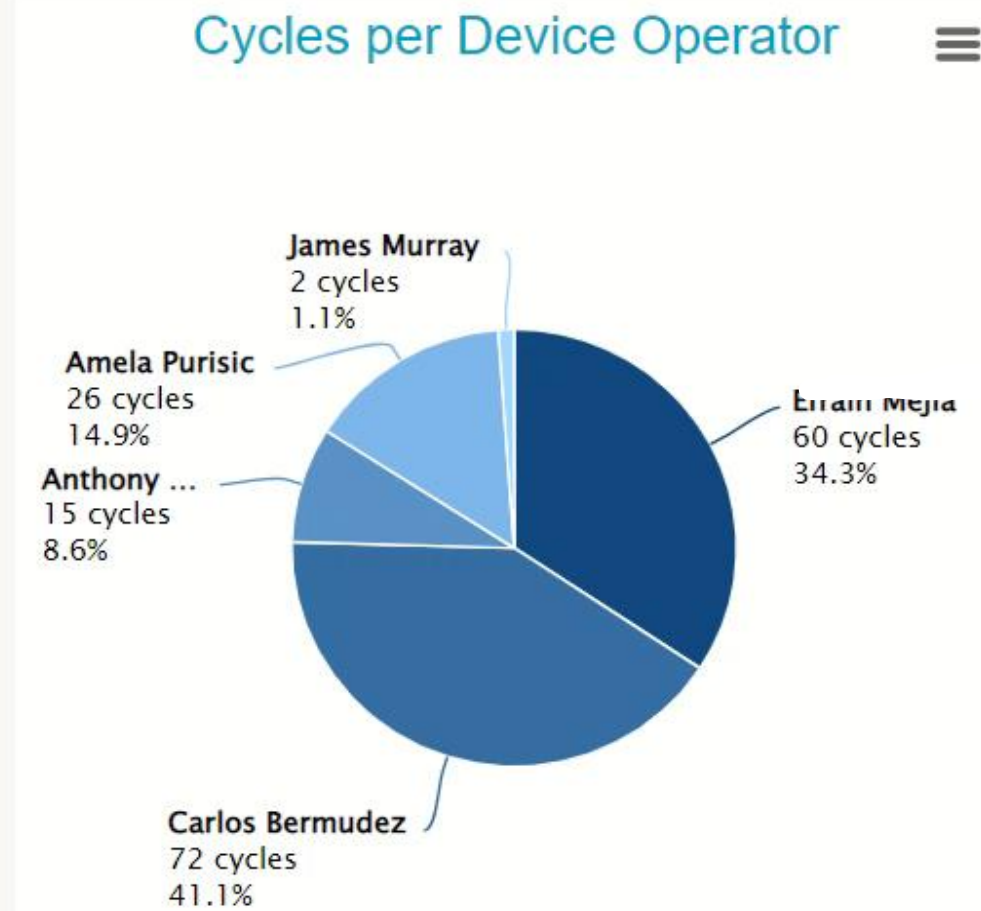
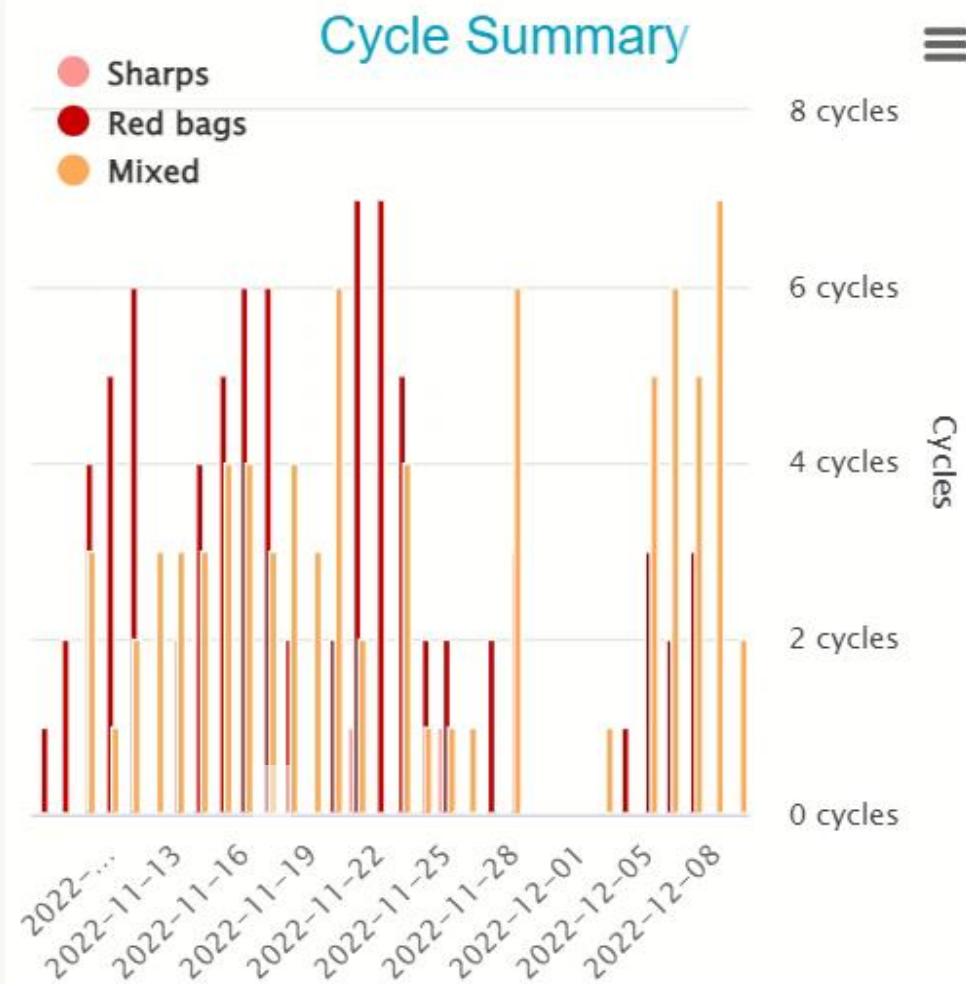

Cycle Report

The active cycle, if any, is displayed in this color.

PDF

CSV

Comprehensive

Compliance



● Pressure
● Temp

Sterilization

Started: 2022-12-09 04:24:58 EST

Switch to
PSI(g)

Max temperature: 137 °C
Max pressure: 52 PSI(a)



ENVIRONMENTAL CONSUMPTION AND OUTPUT



<350 ml Per Cycle



1.0 kw-h Per Cycle Using
Standard Fossil Fuel Energy



Up to 80% Less Waste Volume



CIRCULAR DESIGN AND SUSTAINABILITY

Advanced Recycling



Syringes,
Blood Tubes,
Pipettes



Harmless Confetti



Bio-Hazardous Waste



The Remediator



SMALL CHANGE. BIG IMPACT.
WHAT ARE YOUR GOALS?

Sustainability?

Reduce liability?

Cost reduction?

Green initiatives?

Increase safety?







REMEDIATOR ACT LABEL



Sterilis Solutions Remediator is ACT certified.
 ACT is the world's premier eco-label for laboratory products that ensures Accountability, Consistency, and Transparency to enable sustainable laboratory procurement.



Sterilis Solutions is a proud sponsor of My Green Lab's mission to build a global culture of sustainability in science.



 EU	
Sterilis Solutions Remediator Springfield, MA, USA, North Billerica, MA, USA, & Waynesboro, VA, USA SKU 3823-3000	
Environmental Impact Scale Decreasing Environmental Impact <div style="display: flex; justify-content: space-between; align-items: center;"> 1 10 </div>	
Manufacturing	
Manufacturing Impact Reduction	6.8
Renewable Energy Use	No
Responsible Chemical Management	1.0
Shipping Impact	8.8
Product Content	5.0
Packaging Content	5.0
User Impact	
Energy Consumption (kWh/day)	5.0
Water Consumption (liters/day)	0.8
Product Lifetime	5.0
End of Life	
Packaging	1.0
Product	1.0
Innovation	
Innovative Practices	-1.0
Environmental Impact Factor:	38.4
Label Valid Through:	December 2023
 act.mygreenlab.org	

 US	
Sterilis Solutions Remediator Springfield, MA, USA, North Billerica, MA, USA, & Waynesboro, VA, USA SKU 3823-3000	
Environmental Impact Scale Decreasing Environmental Impact <div style="display: flex; justify-content: space-between; align-items: center;"> 1 10 </div>	
Manufacturing	
Manufacturing Impact Reduction	6.8
Renewable Energy Use	No
Responsible Chemical Management	1.0
Shipping Impact	1.0
Product Content	5.0
Packaging Content	5.0
User Impact	
Energy Consumption (kWh/day)	5.0
Water Consumption (gallons/day)	0.2
Product Lifetime	5.0
End of Life	
Packaging	1.0
Product	1.0
Innovation	
Innovative Practices	-1.0
Environmental Impact Factor:	30.0
Label Valid Through:	December 2023
 act.mygreenlab.org	

 UK	
Sterilis Solutions Remediator Springfield, MA, USA, North Billerica, MA, USA, & Waynesboro, VA, USA SKU 3823-3000	
Environmental Impact Scale Decreasing Environmental Impact <div style="display: flex; justify-content: space-between; align-items: center;"> 1 10 </div>	
Manufacturing	
Manufacturing Impact Reduction	6.8
Renewable Energy Use	No
Responsible Chemical Management	1.0
Shipping Impact	8.2
Product Content	5.0
Packaging Content	5.0
User Impact	
Energy Consumption (kWh/day)	5.0
Water Consumption (liters/day)	0.8
Product Lifetime	5.0
End of Life	
Packaging	1.0
Product	1.0
Innovation	
Innovative Practices	-1.0
Environmental Impact Factor:	37.8
Label Valid Through:	December 2023
 act.mygreenlab.org	

 US	
Sterilis Solutions Remediator Springfield, MA, USA, North Billerica, MA, USA, & Waynesboro, VA, USA SKU 3823-3000	
Environmental Impact Scale Decreasing Environmental Impact <div style="display: flex; justify-content: space-between; align-items: center;"> 1 10 </div>	
Manufacturing	
Manufacturing Impact Reduction	6.8
Renewable Energy Use	No
Responsible Chemical Management	3.0
Shipping Impact	1.0
Product Content	5.0
Packaging Content	5.0
User Impact	
Energy Consumption (kWh/day)	5.0
Water Consumption (gallons/day)	0.2
Product Lifetime	5.0
End of Life	
Packaging	1.0
Product	1.0
Innovation	
Innovative Practices	-1.0
Environmental Impact Factor:	32.0
Label Valid Through:	December 2023
 act.mygreenlab.org	



OUR PRODUCT CAN BE FOUND IN:



SPECIALIZED MEDICAL FACILITIES & CLINICS

- Dental
- Dermatology
- Dialysis
- Hospitals
- Long-Term Acute Care
- Nursing Homes
- Surgery Centers
- Urgent Care
- Veterinary



FIRST RESPONDERS

- Fire Departments / EMS
- Police
- Harm Reduction



LABS

- Clinical Labs
- Reference Labs
- Veterinary Labs
- Toxicology
- Cannabis/Hemp Labs



RETAILERS/PHARMACIES



US GOVERNMENT



AIRPORTS / FBO'S



HOSPITAL ROI EXAMPLES

	80	127	219	670	920
# of Beds	80	127	219	670	920
Volume / month	6,133 lbs	8,058 lbs	8,096 lbs	36,099 lbs	61,290 lbs
Spend / month	\$2,574.00	\$6,872.71	\$4,535.03	\$19,781.89	\$30,675.33
# of Remediators	1	1	1	4	6
Annual Savings	\$16,980.00	\$68,564.52	\$40,512.36	\$181,774.68	\$284,703.96
5 Year Savings	\$94,784.16	\$369,213.81	\$219,976.32	\$984,835.86	\$1,541,313.07

*All numbers shown above are taken from present hospital waste hauling contracts. Sterilis Solutions completed a detailed waste assessment to build an accurate ROI; taking into consideration hours of operation, current hauling spend, and the total volume of waste produced per month.





THANK YOU!

